



www.comet-marine.com

MARINE DISTRESS SIGNALS



WESCOM
Signal & Rescue
World Leading Marine Rescue Signalling Company

Reliability. Performance. Compliance

When you specify lifesaving equipment for your vessel, you need to know – beyond any doubt – that it is the most reliable and cost-effective available. With Comet advanced pyrotechnic marine distress signals, you can be sure you have made the right choice.

The leading light – worldwide

Comet, one of the world's leading brands of pyrotechnics for the commercial and leisure marine markets, has been saving lives around the globe more than half a century.

Our comprehensive range of marine distress signals and safety systems are trusted for their reliability by the world's navies, lifeboat and rescue services, merchant fleets and airlines, as well as by fishing vessels and leisure craft.

The quality, technological superiority and innovative design of our products – combined with worldwide SOLAS approvals, including MED and USCG, and manufacturing to ISO 9001 standard – has placed Comet Marine at the forefront of marine safety.

Through our extensive network of specialist distributors, WesCom Signal and Rescue's range of superior quality distress signals are available, freshly dated, in all major ports around the world.

Full details can be found on the Comet Marine website.

www.comet-marine.com

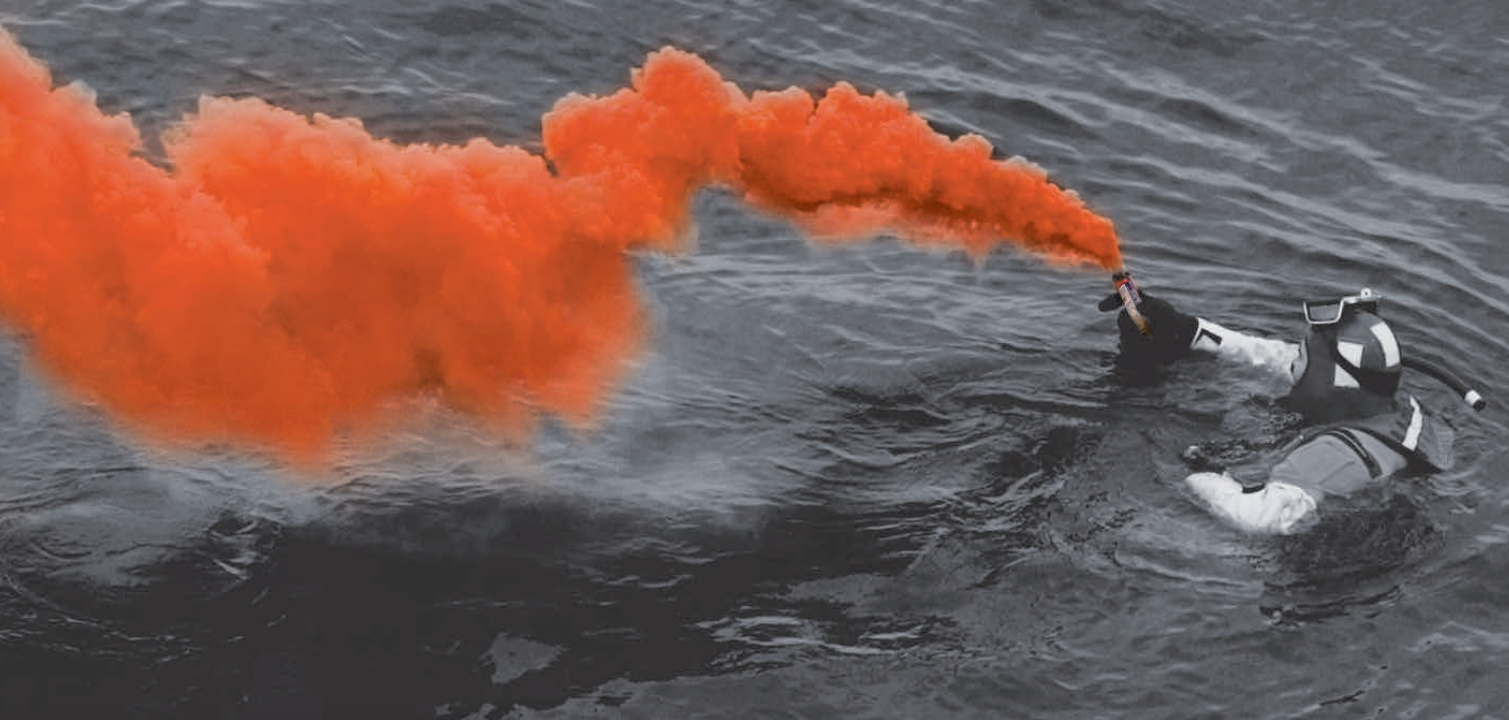

Safety of life at Sea (SOLAS)



Marine Equipment Directive (MED)



United States Coast Guard Approved



European Conformity Mark

Linethrower 250

Art Nos. Complete unit 9160400 · Body and line 9160500 · Rocket 9162700

A self-contained line-throwing appliance consisting of a weatherproof plastic casing with end cap, twist-grip trigger assembly, rocket and line. To comply with SOLAS requirements, four complete rocket and line assemblies (Art. No. 9160400) should be carried on board. The device has a throwing range of between 230m and 250m. A solid propellant is used which guarantees a highly accurate flight path even in strong sidewinds.

For further information on rocket installation – please see page 15.



Rocket

Application

The Comet Linethrower 250 is designed for ease of operation in the most extreme weather conditions. It can be used in all situations where a line is required to be passed accurately and quickly, these include:-

- All line-throwing operations at sea between vessels, ship-to-shore, shore-to-ship and shore based rescue services.
- Rescue of swimmers in distress.
- Line carrying across obstacles and rough terrain.

Operation



1. Remove the front cover and point in the desired flight direction.
2. Pull out safety pin.
3. Aim over the top of target. Be prepared for recoil.
4. Turn grip to left or right to fire.
5. If misfire occurs hold unit in firing position for at least 60 seconds, then dispose of overboard.

Product Life

- Body and line kit: 9 years
- Rocket minimum 3 years
- Spare rockets are available to replace consumed or time expired rockets.

Packing & Transport Information

Body and Line, less rocket in packing case,
L 37 cm (14.57 in) x W 27 cm (10.63 in) x H 27 cm (10.63 in)

- Gross weight 4.2 kg (9.26 lb.)
- Net weight 3.6 kg (7.94 lb.)
- Other Information: Non-hazardous

20 Spare Rockets in metal tin in a fibreboard box,
L 37 cm (14.57 in) x W 27 cm (10.63 in) x H 27 cm (10.63 in)

- Gross Weight Max: 13 kg (28.66 lb.)
- Net Weight Max: 10.70 kg (23.59 lb.)
- Net Explosive Content per box : 2.12 kg (4.67 lb.)
- Hazard class 1.4G
- UN 0431
- Proper shipping name: Articles, Pyrotechnic
- Other Information: Cargo Aircraft Only

Specifications

Projects a line to a nominal range of 250m in calm conditions.

- Length: 33 cm (13.0")
- Height: 31.3 cm (12.3")
- Diameter: 20.5 cm (8.1")
- Gross Weight: 4.7kg (10.36 lb.)
- Net Weight: 4.4 kg (9.7 lb.)
- Rocket Weight Max: 535g (18.9 oz.)
- Explosive Content Max.: 106g (3.74 oz.)
- Line breaking strain: >2 kn

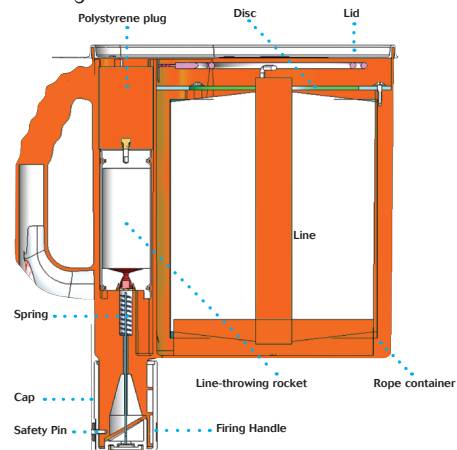

Storage

This compact appliance is ideally stored in a water-resistant locker at ambient temperature allowing easy access in an emergency. The set of 4 appliances normally carried onboard can be dispersed in strategic positions throughout the vessel.

Approvals

Conforms to: BAM 0589-P2-0016 (Complete Unit), 0589-P2-0094 (Rocket only), SOLAS 74 as amended, IMO resolutions MSC. 81(70) Part 1, (MED) 96/98/EC, BGV 424. 002, USCG - and other major maritime authorities worldwide.



WARNING

- Ejects rocket projectile - do not point at people or property
- Do not fire in a confined space
- Keep out of reach of children
- For emergency use at sea
- If damaged or dented do not use
- Do not dismantle
- Keep away from source of heat
- Do not use after expiry date

DISPOSAL

- Pyrotechnics must be treated as hazardous items and must be disposed of responsibly in accordance with local regulations.
- For help and advice, visit our website www.comet-marine.com

Light and Smoke Signal

Art No. 9181600

The Light and Smoke Lifebuoy Marker produces dense orange smoke for 15 minutes and features two self contained, inversion switched, LED lights which far exceed SOLAS requirements for output and duration. Ships are required to carry 2 markers, one mounted on each bridge wing with the brackets supplied and attached by line to a 4kg Lifebuoy. The signal is used to mark the position of a man overboard by day or night. It can be automatically deployed by releasing the attached lifebuoy, or manually activated.

For further information on Light and Smoke Signal installation – please see page 15.



The Comet Smoke Signal Art. No 9181700 is identical, except that it does not feature the lighting system, so is an orange smoke daytime marker only.



Application

- Day and night signal attached to 4kg lifebuoy and used in an emergency to mark the position of man overboard.
- Provides 15 minutes of dense orange smoke.
- Far exceeds SOLAS requirements of 2 hours at 2 candela for light output and duration.
- Safe to use on petrol or oil covered water.
- Lithium batteries sealed for life - no annual replacement.
- Screw fit, inversion switched, LED light units.
- Automatic or manual deployment.
- Universal stainless steel mounting bracket. Usually mounted on a ships bridge wing
- Approved mounting height: 56m - but manufacturer tested to survive 100m drop into water. (SOLAS only requires 30m).
- Ideal for use on ships or rigs with high freeboard.

Operation

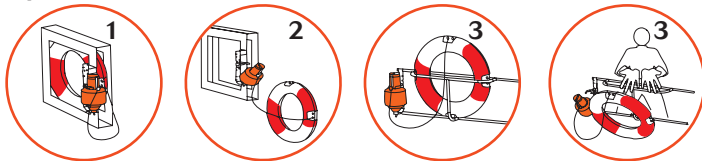

1. Signal and Lifebuoy mounted on bridge wing in ready to fire position.
2. Release locking pin and lifebuoy falls, automatically deploying marker.
3. Alternatively, manually throw lifebuoy overboard.

Packing & Transport Information

- 2 x signals in 1 fibreboard box
- Max. Gross Weight: 9.5 kg (20.94 lb.) per box
- Max. Net Weight: 7.7 kg (17 lb.)
- Measurements of fibreboard box: 36 x 27 x 40 cm (14.2 x 10.6 x 15.8 in)
- Max. Net Explosive Content per box: 2.574kg (5.67 lb.)
- Hazard class 1.4S UN 0507
- Proper shipping name: Signals, Smoke
- Other information: Passenger and cargo aircraft

Specifications

- Height: 375mm (14.76 in)
- Diameter: 183mm (7.20 in)
- Weight: 3.3kg (7.27 lb.)
- Weight – including bracket and angles: 3.85kg (8.5 lb.)
- Net Explosive Content: 1.287kg (2.84 lb.)
- Lamps (bulbs): 2 x 3.6v 2.0A
- Temperature range: -30°C to +65°C
- Burning time: 15 minutes
- Colour of light: white
- Duration: 2 candela for 2 hours
- Use with lifebuoy weighing: 4.0kg (8.82 lb.)
- Attach to lifebuoy with line: 4m (13ft) long, 9.5mm (0.37 in) diameter

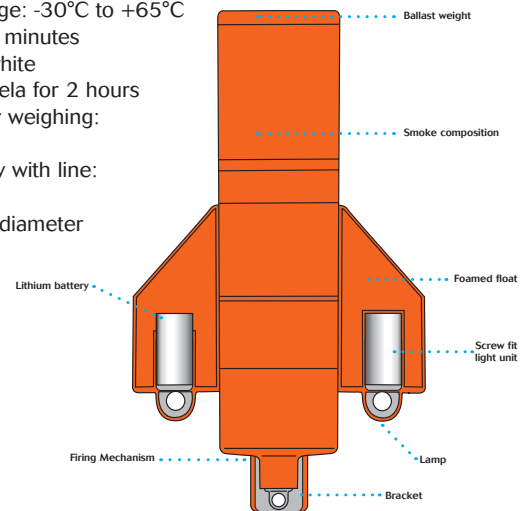

Storage

This compact unit is ideally stored in good magazine conditions in an upright position, mounted to its stainless steel bracket in our original packaging. Onboard vessel: Two units are normally required to be carried. Mounted inverted and attached to a Lifebuoy. Usually positioned on each bridge wing and need a clear, uninterrupted drop into the water.

Approvals

Conforms to SOLAS 74 as amended. IMO Resolution MSC 81 (70) part 1. MED: Light & Smoke Signal - BGV 422.012, Smoke Signal - BGV 422.011, BAM-P1-0596, 0589-P1-0619.



WARNING

- Produces dense orange smoke - do not inhale.
- Do not fire in a confined space
- Keep out of reach of children
- Only for emergency use at sea

- If damaged or dented do not use
- Do not dismantle
- Keep away from source of heat
- Do not use after expiry date

DISPOSAL

- Pyrotechnics must be treated as hazardous items and must be disposed of responsibly in accordance with local regulations. For help and advice, visit our website www.comet-marine.com

Red Parachute Signal Rocket

Art No. 9163100

The Comet Red Parachute Signal Rocket conforms to SOLAS 74 as amended. Designed to withstand exceptional environmental exposure and to perform reliably even after immersion in water, the pull wire ignitor and improved grip provides easy handling. Ejecting a red flare suspended on a parachute at 300m (1000ft), burning for 40 seconds at 30,000 candela.



Application

A day or night long-range distress signal. 12 may be carried on ships bridge and there is a requirement for 4 in ships lifeboats and liferafts. Also suitable for use in other commercial and recreational boats.

Operation

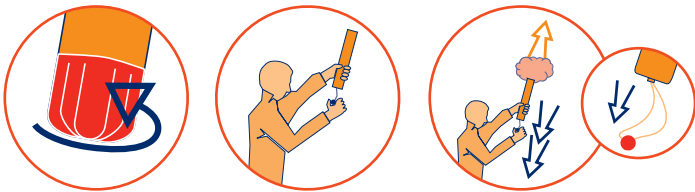

1. Hold signal firmly by ribbed handle. Unscrew RED bottom cap. Do not point at people or property.
2. Hold rocket vertically above head pointing away from body.
3. Ensure hands remain clear of top. To fire - pull red ball sharply down.

Packing & Transport Information

- 56 rockets in 2 metal tins in a fibreboard box
- Gross weight 16.3 kg (35.93 lb.)
- Net weight 13.7 kg (30.20 lb.)
- Measurements of fibreboard box: 47 x 27 x 35 cm (18.5 x 10.6 x 13.8 in)
- Net Explosive Content per box Max: 5.152 kg (11.36 lb.)
- Hazard Class 1.4G | UN 0505
- Proper Shipping Name: Signals, Distress, Ship
- Other Information: Cargo Aircraft Only

Storage

Ideally, should be stored in the robust, specially designed Polybottle, or in a dry, easily accessed location at ambient temperature.

Approvals

Conforms to SOLAS 74 as amended, IMO Resolution 96/98/EC. MED - BGV 425.005, BAM-P2-0059, 0589-P2-0046, USCG and other major maritime authorities world wide.

Specifications

- Length: 287 mm (11.3 in)
- Diameter at handle: 38 mm (1.5 in)
- Diameter: 32 mm (1.25 in)
- Weight Max: 245g (8.23 oz)
- NEC Max: 92g (3.25 oz)
- Light intensity: 30,000 candela
- Burning time: 40 seconds
- Colour of light: red
- Ignition: pull-wire ignitor
- Altitude: 300 m (985 ft)

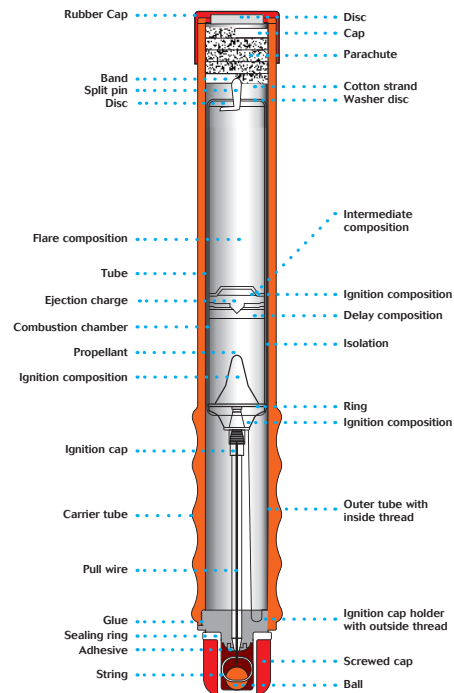

WARNING

- Ejects rocket projectile - do not point at people
- Do not fire in a confined space
- Keep out of reach of children
- Only for emergency use at sea
- If damaged or dented do not use
- Do not dismantle
- Keep away from source of heat
- Do not use after expiry date

DISPOSAL

- Pyrotechnics must be treated as hazardous items and must be disposed of responsibly in accordance with local regulations. For help and advice, visit our website www.comet-marine.com

Smoke Signal Orange

Art No. 9192000

The Smoke Signal Orange is a compact, daylight distress signal designed to be easy and safe to handle. It provides effective position marking during rescue operations and can be used to indicate wind direction, producing dense orange smoke for a minimum of 3 minutes.



Application

The Comet orange smoke signal is a small and compact distress signal for daylight use designed for stowage in liferafts and lifeboats. SOLAS requires 2 smoke signals per raft/boat.

- Signal for position marking during rescue operations
- Indicates wind direction
- Safe use on oil or petrol covered water
- Conforming to SOLAS 74 as amended
- Ideal also for leisure boats

Operation

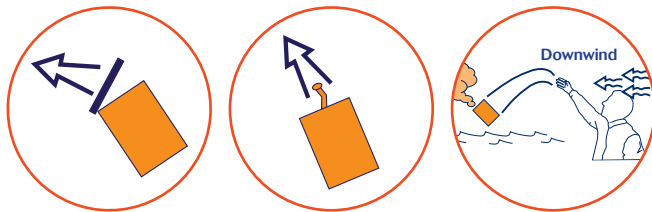

1. Remove plastic cap. Point away from body.
2. Pull tab firmly away from canister. Ensure hand remains clear of HOT END.
3. Throw Lifesmoke overboard immediately. Smoke will be emitted after a 2 second delay.

Packing & Transport Information

- 24 signals in 1 fibreboard box
- Gross weight 9.40 kg (20.72 lb.)
- Net weight 8.90 kg (19.62 lb.)
- Measurements of fibreboard box: 37 x 27 x 27 cm (15 x 11 x 11 in)
- Net Explosive Content per box: 5.736 kg (12.64 lb.)
- Hazard Class 1.4S
- UN 0507
- Proper Shipping Name: Signals, Smoke
- Other Information: Passenger and Cargo Aircraft

Specifications

- Height: 114 mm (4.5 in)
- Diameter: 82 mm (3.2 in)
- Gross Weight Max. 370g (13.05 oz)
- NEC Max. 239g (8.43 oz)
- Burning time: 3 minutes minimum
- Colour of smoke: orange
- Ignition: percussion ignitor with 2 seconds safety delay

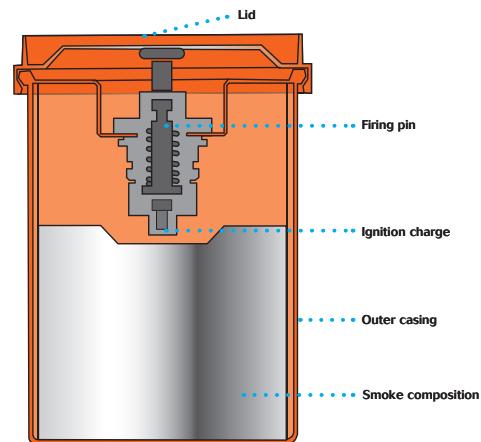

Storage

This compact unit is ideally stored in a water-resistant locker at ambient temperature allowing easy access in an emergency or in the robust, specially designed polybottle.

Approvals

Conforms to SOLAS 74 as amended, Res. MSC 81 (70). Approvals: CE 0589, BAM-P1-0191, 0589-P1-0324, BGV MED 423.008, USCG 160.122./21/0, 160.022/21/0, and other major maritime authorities worldwide.



WARNING

- Produces dense orange smoke – do not inhale
- Do not fire in a confined space
- Keep out of reach of children
- Only for emergency use at sea
- If damaged or dented do not use
- Do not dismantle
- Keep away from source of heat
- Do not use after expiry date

DISPOSAL

- Pyrotechnics must be treated as hazardous items and must be disposed of responsibly in accordance with local regulations. For help and advice, visit our website www.comet-marine.com

Red Handflare

Art No. 9162800

The Handflare MK8 conforms to SOLAS 74 as amended. Designed to withstand exceptional environmental exposure and to perform reliably even after immersion in water. Featuring a telescopic handle with improved grip, making it very compact for stowage. Easily extended for safe handling and operation by pull wire ignitor. Produces hot red flame for 60 seconds at 15000 candela.



Application

For use day or night the Comet Red Handflare is a short-range distress signal used to pinpoint position. May be carried on ships bridge and six are required to be fitted in ships lifeboats and liferafts. The handflare is suitable for use on other commercial and recreational boats. Also available is the Comet White Collision Warn-off Handflare which is for use day or night when a collision danger exists or for the illumination of small areas outside. (Art No. 9162500)

Operation

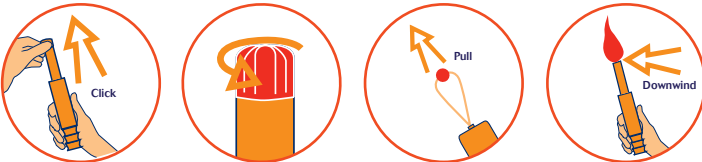

1. Pull out red end until telescopic tube is fully extended and engaged.
2. Unscrew red end cap and point away.
3. Pull ball out sharply to fire.
4. Hold at arms length. Point Downwind. End plug ejects after 2 seconds delay.

Packing & Transport Information

- 100 flares in 1 fibreboard box
- Gross Weight Max: 18.20 kg (40.12 lb.)
- Net Weight Max: 17.6 kg (38.8 lb.)
- Measurements of fibreboard box: 37 x 27 x 27cm (15 x 11 x 11 in)
- Net Explosive Content per box Max: 6.3 kg (13.89 lb.)
- Hazard Class 1.4G 1 UN 0191
- Proper Shipping Name: Signal Devices, Hand
- Other Information: Cargo Aircraft Only

Storage

Ideally, both products should be stored in the robust, specially designed Polybottle, or in a dry, easily accessed location at ambient temperature.

Specifications

- Length: 175mm (6.9 in)
- Length with handle pulled out: 280mm (11 in)
- Diameter: 28mm (1.1 in)
- Weight Max: 176g (6.2 oz)
- Light intensity: 15,000 candela
- Burning time: 60 seconds
- Colour of light: red
- Ignition: pull-wire ignitor
- Net Explosive Content Max.: 63g (2.22 oz)

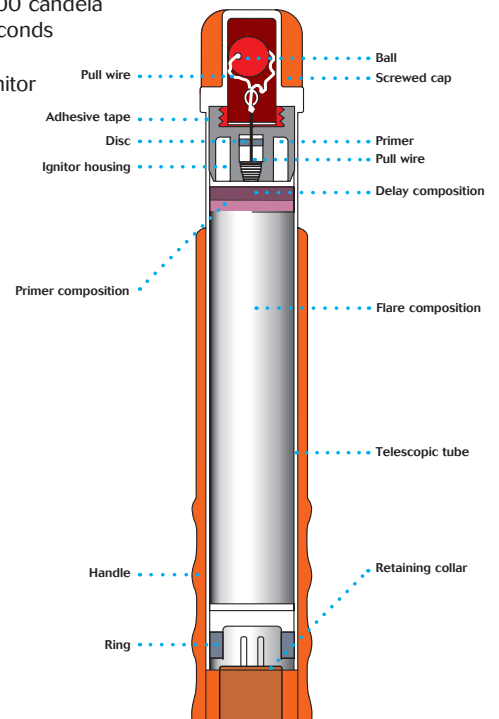

Approvals

Conforms to: SOLAS 74 as amended, IMO resolution MSC. 81(70) Part 1, (MED) 96/98/EC, BGV 426.004, BAM -P1-0594, 0589-P1-0617, USCG and other major maritime authorities worldwide.



WARNING

- Produces red hot flame - do not point at people
- Do not fire in a confined space
- Keep out of reach of children
- Only for emergency use at sea
- If damaged or dented do not use
- Do not dismantle
- Keep away from source of heat
- Do not use after expiry date

DISPOSAL

- Pyrotechnics must be treated as hazardous items and must be disposed of responsibly in accordance with local regulations. For help and advice, visit our website www.comet-marine.com

Day & Night Signal

Art No. 9131500

The compact, handheld Comet Day & Night Signal consists of a red flare at one end and an orange smoke at the other. Housed in a rugged, corrosion-resistant case and protected by end caps with 'O' ring seals.



Application

This handheld signal has been designed for personal distress signalling and is ideal for divers, windsurfers, dinghy sailors and small boats operating inshore as well as outdoor pursuits such as mountaineering, and was originally designed for helicopter/aircrew.

- Incorporates a red flare 15,000 candela at one end, for use at night and day, and a dense orange smoke at the other for daytime use.
- Both ends can be fired independently and can be doused in water after firing, allowing the unused end to be stowed until required.

Operation (identical both ends)



FOR DAY OR NIGHT USE ONLY WHEN RESCUE SERVICES ARE SIGHTED

1. Select the end to be used – smoke by day, flare at night. Due to its high power the flare also has good visibility by day if required.

The Signal has differently coloured and ribbed end caps to aid identification at night.

2. Remove end cap.
3. Hold clear of face and point downwind.
4. To activate – pull toggle sharply away from body.

Packing & Transport Information

- 100 signals in fibreboard carton
- Gross weight: 19.3 kg (45.55 lb.)
- Net Weight: 18.7 kg (41.23 lb.)
- Measurements of fibreboard box: 37 x 27 x 27 cm (15 x 11 x 11 in)
- Net Explosive Content per carton: 5.14 kg (11.33 lb.)
- Hazard Class: 1.4G
- UN 0191
- Proper Shipping name: Signal Devices, Hand
- Other Information: Cargo Aircraft Only

Storage

Ideally, should be stored in the robust, specially designed Polybottle, or in a dry, easily accessed location at ambient temperature.

Specifications

- Length: 190mm (7.48 in)
- Diameter: 30mm (1.18 in)
- Burning time: Smoke 18 seconds, Flare 20 seconds
- Light intensity: 15,000 candela
- Colour of smoke: Orange
- Colour of flare: Red
- Weight: 187g (6.603oz)
- NEC: 51.49g (1.8 oz)
- Ignition: Pull wire ignitor



WARNING

- Produces red hot flame - do not point at people
- Produces dense orange smoke - do not inhale
- Do not fire in a confined space
- Keep out of reach of children
- Only for emergency use at sea
- If damaged or dented do not use
- Do not dismantle
- Keep away from source of heat
- Do not use after expiry date

DISPOSAL

- Pyrotechnics must be treated as hazardous items and must be disposed of responsibly in accordance with local regulations. For help and advice, visit our website www.comet-marine.com



Parachute Illuminating Rocket

Art No. 9123700

The Comet Parachute Illuminating Rocket is used in Search and Rescue operations at night or for collision warning. Designed to withstand exceptional environmental exposure and to perform reliably even after immersion in water, the pull wire ignitor and improved grip provides easy handling. The rocket ejects a white flare suspended on a parachute at 300m (1000ft), which burns for 30 seconds at 90,000 candela.

Application

A day or night collision warning signal, or used at night to illuminate areas for Search and Rescue operations. Suitable for use in commercial vessels, recreational boats and rescue services.

Operation

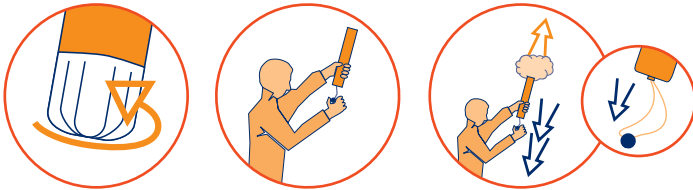

1. Hold signal firmly by ribbed handle. Unscrew WHITE bottom cap.
Do not point at people or property.
2. Hold rocket vertically above head pointing away from body.
3. Ensure hands remain clear of top. To fire – pull red ball sharply down.

Packing & Transport Information

- 56 rockets in 2 metal tins in a fibreboard box
- Gross weight 17.2 kg (37.92 lb.)
- Net weight 14.6 kg (32.18 lb.)
- Measurements of fibreboard box:
47 x 27 x 35 cm (18.5 x 10.6 x 13.8 in)
- Net Explosive Content per box: 5.152 kg (11.36 lb.)
- Hazard Class 1.4G
- UN 0505
- Proper Shipping Name: Signals, Distress, Ship
- Other Information: Cargo Aircraft Only

Storage

Ideally, should be stored in the robust, specially designed Polybottle, or in a dry, easily accessed location at ambient temperature.

Approvals

CE 0589, BAM- P2-0060, BAM 0589-P2-0056

Specifications

- Length: 287 mm (11.3 in)
- Diameter at handle: 38 mm (1.5 in)
- Diameter: 32 mm (1.25 in)
- Nominal weight: 260 g (9.17 oz)
- Net explosive cont: 92 g (3.2 oz)
- Light intensity: 90,000 candela
- Burning time: 30 seconds
- Colour of light: white
- Ignition: pull-wire ignitor
- Altitude: 300 m (985 ft)



WARNING

- Ejects rocket projectile – do not point at people or property
- Do not fire in a confined space
- Keep out of reach of children
- Only for emergency use at sea
- If damaged or dented do not use
- Do not dismantle
- Keep away from source of heat
- Do not use after expiry date

DISPOSAL

- Pyrotechnics must be treated as hazardous items and must be disposed of responsibly in accordance with local regulations. For help and advice, visit our website www.comet-marine.com



White Handflare

Art No. 9162500

The White Handflare is for use as a collision warning signal or for illumination of small areas. Designed to withstand exceptional environmental exposure and to perform reliably even after immersion in water. Featuring a unique telescopic handle with improved grip, making it very compact for stowage. Easily extended for safe handling and operation by pull wire ignitor. Produces hot white flame for 60 seconds at 2,500 candela.

Application

For use by day or night as a short-range collision warning signal, to pinpoint position and to illuminate small areas at night. These may be carried on the ship's bridge and are recommended for yachts making night passages. Four white handflares are included in our RORC kits. Also available is the similar red handflare (Art No. 9162800), which is used to signal distress.

Operation



1. Pull out white end until telescopic tube is fully extended and engaged.
2. Unscrew white end cap and point away.
3. Pull ball out sharply to fire.
4. Hold at arms length. Point Downwind. End plug ejects after 2 seconds delay.

Packing & Transport Information

- 100 flares in 1 fibreboard box
- Gross weight 17.6 kg (38.80 lb.)
- Net weight 17 kg (37.48 lb.)
- Measurements of fibreboard box: 37 x 27 x 27cm (15 x 11 x 11 in)
- Net Explosive Content per box: 6 kg (13.23 lb.)
- Hazard Class 1.4G
- UN0191
- Proper Shipping Name: Signal Devices Hand
- Other Information: Cargo Aircraft Only

Storage

The telescopic handle saves stowage space. Ideally, both red and white handflares should be stored in our robust, specially designed polybottles, or in a dry, easily accessed location at ambient temperature. Do not store near sources of heat.

Specifications

- Length: 175mm (6.9 in)
- Length with handle pulled out: 280mm (11 in)
- Diameter: 28mm (1.1 in)
- Weight: 170g (6.003oz)
- Light intensity: 2,500 candela
- Burning time: 60 seconds
- Colour of light: white
- Ignition: pull wire ignitor
- Net explosive content: 60g (2.12oz)

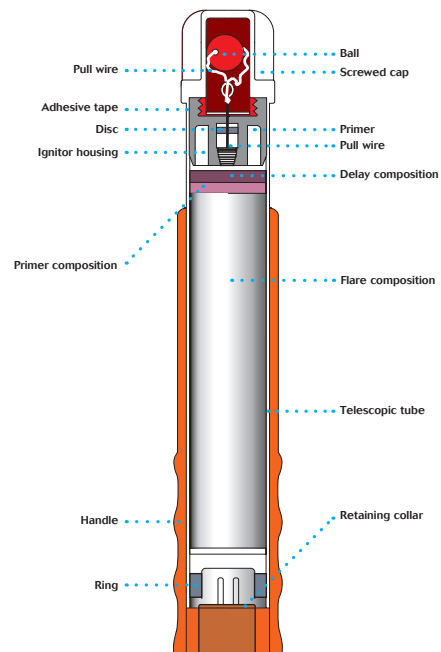

WARNING

- Produces white hot flame – do not point at people
- Do not fire in a confined space
- Keep out of reach of children
- Only for emergency use at sea
- If damaged or dented do not use
- Do not dismantle
- Keep away from source of heat
- Do not use after expiry date

DISPOSAL

- Pyrotechnics must be treated as hazardous items and must be disposed of responsibly in accordance with local regulations. For help and advice, visit our website www.comet-marine.com

Orange Handsmoke

Art No. 9132600

The Orange Handsmoke is a hand-held marine distress signal for daytime use to indicate position and wind direction. Produces dense orange smoke for 60 seconds.



Application

Daytime, short range distress signal, used to pinpoint position and indicate wind direction once potential rescuer is sighted. Ideal for use on yachts, dinghies, RIBs, canoes and is included in our Inshore and Coastal kits.

Operation

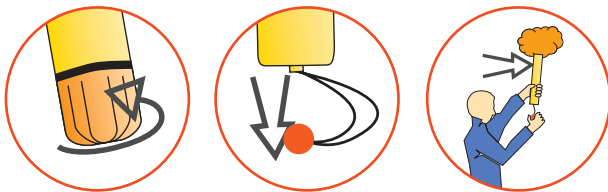

1. Unscrew bottom brown end cap and point away from body
2. To ignite - pull toggle down sharply
3. Hold at arms length, downwind and outboard

Packing & Transport Information

- 50 signals in fibreboard box
- Gross Weight Max per pack: 8.8 kg (19.4 lb.)
- Net Weight Max per pack: 8.3 kg (18.3 lb.)
- Measurements of fibreboard box: 37 x 27 x 27 cm (15 x 11 x 11 in)
- Net Explosive Max Content per box: 2.775kg (6.12 lb.)
- Hazard Class: 1.4G
- UN 0197
- Proper Shipping name: Signals, Smoke
- Other information: Cargo Aircraft Only

Storage

Should be stored in either the mini or large Polybottle in a dry, easily accessed location at ambient temperature.

Specifications

- Length: 24.3cm (9.57 in)
- Burning Time: 60 seconds
- Diameter: 3.8cm (1.5 in)
- Colour of Smoke: Orange
- Weight Max: 165g (5.82 oz)
- Ignition: Pull - wire ignitor
- Net Explosive Content Max: 55.5g (1.96 oz)

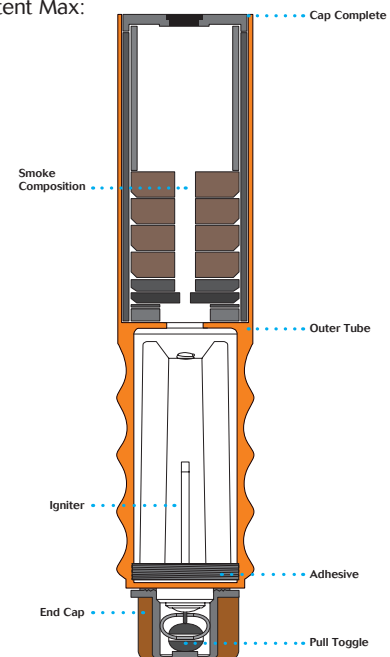

WARNING

- End plug ejected – do not point at people
- Produces dense orange smoke – do not inhale
- Do not fire in a confined space
- Keep out of reach of children



- Only for emergency use at sea
- If damaged or dented do not use
- Do not dismantle
- Keep away from source of heat
- Do not use after expiry date

DISPOSAL

- Pyrotechnics must be treated as hazardous items and must be disposed of responsibly in accordance with local regulations. For help and advice, visit our website www.comet-marine.com



Personal Signal Launcher

Art No. 9194600

The lightweight, Comet Personal Signal Launcher pack contains 9 red aerial flare cartridges and a penjector firing mechanism, all enclosed in a tough, water-resistant case. The penjector is fitted with a stainless-steel spring and striker pin. It features a slot for easy loading and unloading of the flare cartridge with the trigger in the safety catch position.

Application

Comet Personal Signal Launcher are designed primarily for use on yachts, dinghies, Personal Water Craft, canoes and sailboards, but have many applications as a general-purpose distress signal for aviation, hill-walking, climbing, skiing and other outdoor pursuits. Each cartridge projects its payload to a height of 50 metres, burns for over 5 seconds at a minimum of 10,000 candela and is visible for at least 5 miles in daylight increasing to 10 miles at night, depending on weather conditions. Operating instructions are on the case.

Operation

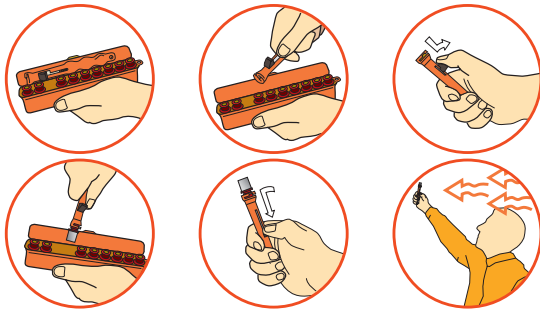

For day or night-use only when rescue services are sighted

1. Open case.
2. Remove penjector from pack.
3. Place trigger in safety catch position.
4. Load the flare cartridge by sliding into slot on penjector.
5. To fire, hold the penjector firmly at arms length above and away from face and body, pull back penjector trigger and release – fire vertically and be prepared for slight recoil and loud report.

Packing & Transport Information

- 50 kits per fibreboard carton
- Gross weight: 10.1 kg (22.27 lb.)
- Net weight: 9.5 kg (20.94 lb.)
- Hazard Class: 1.4G
- Net Explosive Content per carton: 2.4 kg (2.59 lb.)
- Measurements of carton: 37 x 27 x 27 cm (15 x 11 x 11 in)
- UN 0312
- Proper Shipping Name: Cartridges, Signal
- Other Information: Cargo Aircraft only

Storage

When not carried, the signal should be stored in our robust, specially designed Polybottle, or in a dry location at ambient temperature.

Specifications

- Application: For use in day and night distress signal situations
- Dimensions: 180mm x 58mm x 25mm (7.1 x 2.28 x 1.0 in)
- Height: 50 metres (164')
- Net Explosive Content: Approx 48g per set (1.69 oz)
5.25g per cartridge (0.19 oz)
- Burning time: over 5 seconds
- Light intensity: 10,000 candela
- Weight: 190g (6.7oz) in display box
147g (5.19oz) just the magazine filled with nine cartridges and the signal pen



WARNING

- Ejects projectile – do not point at people or property
- Do not fire in a confined space
- Keep out of reach of children
- Only for emergency use
- If damaged or dented do not use
- Do not dismantle
- Keep away from sources of heat
- Do not use after expiry date

DISPOSAL

- Pyrotechnics must be treated as hazardous items and must be disposed of responsibly in accordance with local regulations. For help and advice, visit our website www.comet-marine.com



Compact Signal Launcher

Art No. 9194700

The lightweight, Comet Compact Signal Launcher contains 3 red aerial flare cartridges and a penjector firing mechanism, all enclosed in a tough, water-resistant case. The penjector is fitted with a stainless-steel spring and striker pin. It features a slot for easy loading and unloading of the flare cartridges. These are stored inside the casing on an elastic lanyard to avoid them being lost when the base cap is unscrewed.

Application

Compact Signal Launchers are designed primarily for use on yachts, dinghies, Personal Water Craft, canoes and sailboards, but have many applications as a general-purpose distress signal for aviation, hill-walking, climbing, skiing and other outdoor pursuits. Each cartridge projects its payload to a height of 50 metres, burns for over 5 seconds at a minimum of 10,000 candela and is visible for at least 5 miles in daylight increasing to 10 miles at night, depending on weather conditions. Operating instructions are on the case.

Operation

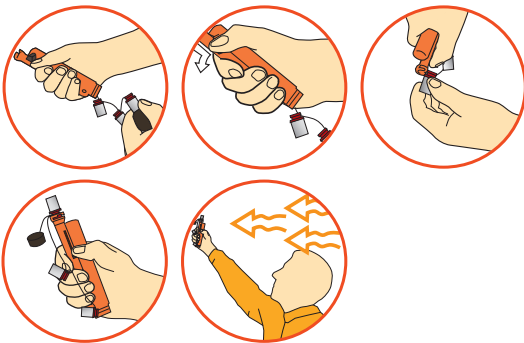

For day or night-use only when rescue services are sighted

1. Unscrew base cap.
2. Place trigger in safety catch position.
3. Load the flare cartridge attached to lanyard by sliding into slot on penjector.
4. To fire, hold the penjector firmly at arms length above and away from face and body, pull back penjector trigger and release – fire vertically and be prepared for slight recoil and loud report

Packing & Transport Information

- 50 kits per fibreboard carton
- Gross weight: 6.9 kg (15.21 lb.)
- Net weight: 6.3 kg (13.89 lb.)
- Hazard Class: 1.4G
- Net Explosive Content per carton: 0.8 kg (1.76 lb.)
- Measurements of carton: 37 x 27 x 27 cm (15 x 11 x 11 in)
- UN 0312
- Proper Shipping Name: Cartridges, Signal
- Other Information: Cargo Aircraft only

Storage

When not carried, the signal should be stored in our robust, specially designed Polybottle, or in a dry location at ambient temperature.

Specifications

- Application: For use in day and night distress signal situations
- Dimensions: 145mm x 40mm x 25mm (5.7 x 1.6 x 1.0 in)
- Net Explosive Content: Approx 16g per pack (0.56 oz)
5.25g per cartridge (0.19 oz)
- Burning time: over 5 seconds
- Height: 50 metres (164')
- Light intensity: 10,000 candela
- Weight: 125g (4.41 oz) in display box
80g (2.82) just the signal pen filled with three cartridges



WARNING

- Ejects projectile – do not point at people or property
- Do not fire in a confined space
- Keep out of reach of children
- Only for emergency use
- If damaged or dented do not use
- Do not dismantle
- Keep away from sources of heat
- Do not use after expiry date

DISPOSAL

- Pyrotechnics must be treated as hazardous items and must be disposed of responsibly in accordance with local regulations. For help and advice, visit our website www.comet-marine.com



Signal Cartridges



Parachute Signal Cartridges



Signal Pistol and Cartridges

Calibre 4/26.5mm. Art Nos. Pistol 9121852

Signal Cartridges Red 9182000 • White 9182100 • Green 9182200 • Maroon 9122500

Parachute Signal Cartridges Red 9122600 • White 9122700

Signal Pistol Features

Note: Pistols are re-conditioned and supplied as 'Pre-used' from authorised stock

- Solid and robust, easy to operate • Bronzed barrel with plastic handle
- Fires range of distress, illuminating, maroon and signalling Very cartridges
- Free falling and parachute varieties • Can be used for flare stack lighting

Signal Cartridge Features

- Easy handling • Easy identification
- Coloured caps signify flare colour and notched edges aid identification at night
- Red flare = Full edging and signals distress
- White flare = half edging and signals collision warning and briefly illuminates the foreground
- Green flare = no edging and used as a general signal
- Maroon flare = no edging and produces an acoustic and optical signal (flash and bang)
- Red parachute flare = full edging and signals distress
- White parachute flare = half edging and signals collision warning and illuminates the foreground

Signal Pistol

Specifications

- Total length: 215mm (8.5 in)
- Length of barrel: 155mm (6.1 in)
- Pistol weight: 600g (21.2 oz)

Firearm

- The trade in firearms requires an arms trade permit
- Purchase of firearms is only allowed if you possess a valid firearms licence

Cartridges

Specifications

Signal Cartridges

- Length: 80mm (3.15 in)
- Diameter: 26.5mm (1 in) (Cal.4)
- Cartridge case: Plastic
- Height: 100m (328ft) +/- 20 m (66ft)
- Burning time: 8 secs
- Art No. 9182000 = Red >30,000 candela
Net Explosive Content: 18g (0.63oz)
Weight: 34.7g each (1.22oz)
- Art No. 9182100 = White >40,000 candela
Net Explosive Content: 28.5g (1.01oz)
Weight: 46.8g (1.65oz)
- Art No. 9182200 = Green >10,000 candela
Net Explosive Content: 20.5g (0.72oz)
Weight: 37.8g each (1.33oz)

- Art No. 9122500 = Maroon
Net Explosive Content: 14.2g (0.50oz)
Weight: 62g each (2.19oz)
Cartridge case = Aluminium
Height: 120m (394 ft)
Produces a flash with a cloud of smoke and a loud report of 170 decibels at 3m (10ft) distance and 1m (3.3ft) height

Parachute Cartridges

- Length: 170mm (6.7 in)
- Diameter: 26.5mm (1 in) Cal 4
- Weight: 138g (4.83oz)
- Cartridge case = Aluminium
- Height: 300m (984ft)
- Burning time: 30 seconds
- Net Explosive Content: 50g (1.75oz)
- Red = >15,000 candela
- White = >30,000 candela

Packing & Transport Information

Signal Cartridges

- Measurements of carton: 37 x W 27 x H 27 cm (L 14.57 x W 10.63 x H 10.63 in)
- Gross Weight
Red: 10.5 kg (23.17 lb.)
White: 13.5 kg (29.77 lb.)
Green: 11.2 kg (24.70 lb.)
Maroon: 17.3 kg (38.14 lb.)

- Net Weight without inner box
Red: 8.7 kg (19.12 lb.)
White: 11.7 kg (25.80 lb.)
Green: 9.5 kg (20.94 lb.)
Maroon: 15.5 kg (34.17 lb.)
- Net Explosive Content per carton
Red: 4.5 kg (9.92 lb.)
White: 7.1 kg (15.65 lb.)
Green: 5.1 kg (11.24 lb.)
Maroon: 3.5 kg (7.49 lb.)
- Hazard Class 1.4G, Maroon 1.3G
- UN 0312, Maroon UN 0054
- Proper Shipping Name: Cartridges, Signal
- Other Information: Cargo Aircraft Only

Parachute Cartridges

- 12 Parachute cartridges in a paper box
- 120 cartridges in a carton
- Measurements of carton: L 37 x W 27 x H 27 cm (L 14.57 x W 10.63 x H 10.63 in)
- Gross Weight: Red 17.5 kg (38.58 lb.)
- Gross Weight: White 17 kg (37.48 lb.)
- Net Weight: Red 16.6 kg (36.6 lb.)
- Net Weight: White 16.1 kg (35.49 lb.)
- Net Explosive Content per carton: 6kg (13.23 lb.)
- Hazard Class: 1.4G
- UN 0312
- Proper Shipping Name: Cartridges, Signal
- Other information: Cargo Aircraft only

Pistol

- Pistol wrapped in paper in cardboard carton
- Total weight approx.: 680g (24oz)



WARNING

- Ejects projectile - do not point at people or property
- Do not fire in a confined space
- Keep out of reach of children
- If damaged or dented do not use



- Do not dismantle
- Keep away from source of heat
- Do not use after expiry date

DISPOSAL

- Pyrotechnics must be treated as hazardous items and must be disposed of responsibly in accordance with local regulations. For help and advice, visit our website www.comet-marine.com

Polybottles

Rugged, buoyant containers, ideal for storing distress signals. Can be easily picked up in an emergency.



Art no. 9128000
Large Polybottle
(waterproof)
12 litre (2.64gal) capacity



Art no. 9128900
Mini Polybottle
(water resistant)
3 litre (0.8gal) capacity

Linethrower 250 Rocket Installation Instruction

1. Inspect the container before changing the rocket for damage and signs of wear. A damaged device must not be used again. Remove the cover of the container and withdraw the white stoppers in the upper part of the container (1.1).

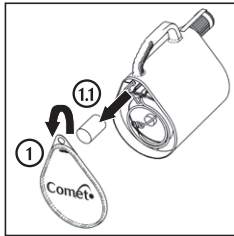

Attention: In no circumstances are you to remove the stoppers from the middle of the cable coil!

- 2a. Replace old rocket. Extract the rocket completely from the rocket shaft of the container and separate from the cord (2.1).

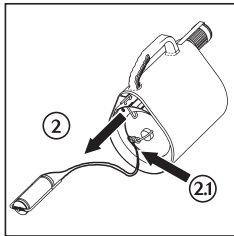

- 2b. Install new rocket.
3. Connect the new rocket with the cord (Bowline) and let them slide into the rocket shaft. The bracket must be guided under the tracks (3.1).

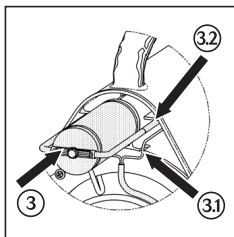

Attention: The rocket should only slide into the rocket shaft through its own dead weight. Pay attention to the correct position of the pull jack. The steel cables of the pull jack run into the rocket shaft beneath the rocket and are guided through slots on the floor of the shaft (3.2). Ensure that the knotting of the cord end (Slipstek) does not hinder the rockets when firing. Fix the rocket in the bottom of the rocket shaft, place the white polystyrene plug on top and seal the container with the white top cover.

4. Attach date stickers to the device where the designated place of the product label should be.

Light & Smoke Signal Mounting, Operating and Test Instructions

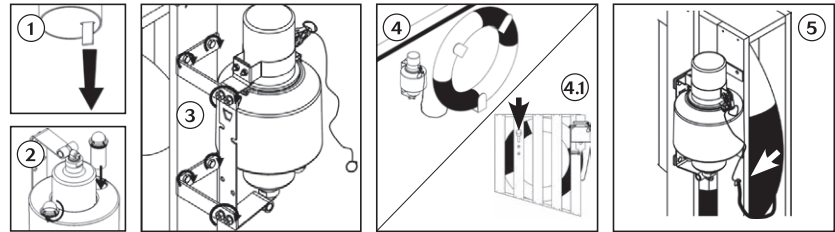

MOUNTING INSTRUCTION

- 1 Remove transit tag from base of light units. Check lights work by inverting units. Note: Lights only operate when upright and without transit tags.
- 2 Screw lights firmly into their holders in the float.
- 3 Fasten mounting bracket on outside of bridge wing bulwarks. Select mounting point to avoid vibration as much as possible. With Lifebuoy shute –fasten the right angled brackets on outboard side of lifebuoy shute. Screw mounting bracket to right angled brackets.
- 4 Install lifebuoy into bracket (4). Or-install lifebuoy into shute and fix by locking pin.(4.1)
- 5 Tie the connection line of the lifebuoy to the pull cord of the Light Smoke signal. (Minimum 3.6m of line)
Avoid at any time applying strong tension on the safety clip of the pull cord. Danger of unintended release of signal.

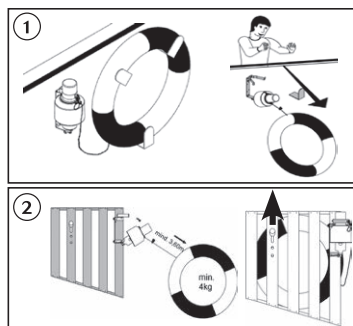

OPERATING INSTRUCTIONS

- 1 In case of a man overboard, throw lifebuoy overboard and the signal will be released automatically.
- 2 Attached to Lifebuoy shute: Remove pin and weight of lifebuoy will automatically release the signal. Signal produces dense orange smoke for 15 minutes and white lights for 2 hours at 2 candela minimum.

TESTING THE LIGHTS

- 1 The signal is designed to be 'fit and forget' for its entire service life.
- 2 Annual testing of lights is not required.
- 3 The LED lights are operated by a lithium battery and a tilt switch. They will remain 'OFF' until the signal is turned upright.
- 4 If a light test is required. Each light unit can be carefully unscrewed and removed from the holder in the float.
Hold unit upright to turn the light on. Screw units firmly back into holders. Take care not to drop the lights!



www.comet-marine.com



Worldwide support

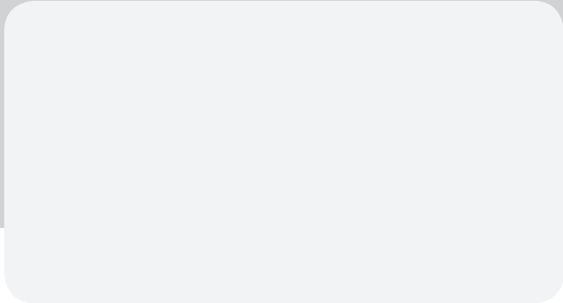

www.wescomsignal.com E-mail: info@wescomsignal.com Tel: +44 (0) 2392 415700